

A comparative study on computational methods to solve tangram puzzles

Fernanda Miyuki Yamada

Center for Mathematics, Computing and Cognition

Federal University of ABC

Santo Andre, Brazil

Email: fernanda.yamada@aluno.ufabc.edu.br

Harlen Costa Batagelo

Center for Mathematics, Computing and Cognition

Federal University of ABC

Santo Andre, Brazil

Email: harlen.batagelo@ufabc.edu.br

Abstract—The tangram is a dissection puzzle composed of seven polygonal pieces which can be combined to form different patterns. Besides being a recreational puzzle, the tangram relates to a more general class of combinatorial NP-hard problems such as the bin packing problem and jigsaw puzzles. In this paper, we propose a comparative study of current computational methods for automatically solving tangram puzzles. In particular, we propose to implement and compare four approaches that employ strategies based on computational heuristics, genetic algorithms, artificial neural networks and algebraic representations. We intend to identify their similarities, their strengths and weaknesses in order to better understand the tangram puzzle problem, ultimately leading to an improved computational method for solving dissection puzzles.

I. INTRODUCTION

The tangram is a geometric puzzle composed by seven polygonal pieces: a square, a parallelogram, and five triangles of different sizes. In Figure 1, the pieces are presented in their initial square configuration.

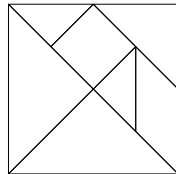

Fig. 1. Tangram pieces in the initial configuration.

The goal of the tangram puzzle is to rearrange the seven pieces using rigid body transformations in order to fit them into a given pattern composed of simply-connected or multiply-connected planar regions [1]. All seven pieces must be used and they may not overlap. When the pieces contact each other, vertex-to-vertex, vertex-to-edge, and edge-to-edge contacts are allowed. The tangram puzzle relates to a more general class of combinatorial problems such as the bin packing problem and the jigsaw puzzle problem, both of which are known to be NP-hard problems.

In this study, we present preliminary results of a comparative study of existing computational techniques for solving tangram puzzles. Our goal is to identify the advantages and weaknesses of each method in order to identify room for improvement of techniques for solving dissection puzzles. We

focus on four approaches which include methods developed solely for tangram puzzles, but also methods originally developed for jigsaw or edge-matching puzzles that can be extended to tangram puzzles. So far, we have implemented and analyzed the heuristic approach described by Deutsch & Hayes [2].

In Section II we present a synthesis of the literature of computational tangram solving techniques. A preliminary comparison considering what the authors presented in their works is presented in Section III. In Section IV we present our methodology to conduct the implementation and comparison. Preliminary results of our implementation of the heuristic method are presented and discussed in Section V.

II. COMPUTATIONAL METHODS TO SOLVE TANGRAM PUZZLES

Most computational puzzle solving techniques are dedicated to jigsaw [3] and edge-matching [4] puzzles. From these techniques, we have identified two approaches which include extensions to dissection puzzles such as the tangram: one based on genetic algorithms [5], and a more recent approach based on the solution of systems of polynomial equations derived from the pieces of the puzzle [6]. According to our survey, only two methods were proposed exclusively for tangram puzzles: an approach based on heuristic programming [2] and a technique based on neural networks [7]. Since the study of these techniques is the main objective of this paper, we present a brief overview of these works in the following subsections.

A. Method based on heuristic programming

Deutsch & Hayes [2] presented two approaches to solve tangram puzzles. The first one is a combinatorial approach, in which the algorithm tests various possibilities of positioning the pieces and, by trial and error, finds the desired solution. Its obvious drawback is the high processing time, since the problem deals with a large solution space. In order to tackle that, the authors focus on a proposal based on heuristic programming. Initially, the algorithm performs attempts to partition a desired polygonal pattern into smaller parts called sub-puzzles. The algorithm follows the contour of the pattern and, in convex corners (from internal angles), generates so-called *extension lines* that determine a possible section of the pattern. In Figure 2, extension lines are shown as dashed lines.

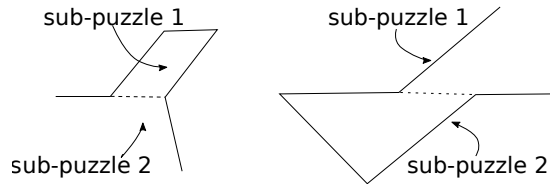

Fig. 2. Example of the pattern partition into sub-puzzles [2].

In order to separate the pattern into sub-puzzles, the method applies ten rules that consider the relation between the edges of the pattern and the extension lines with the pieces and the composites, which are regions formed by a set of pieces. Two of these rules summarize the general idea of the algorithm and are presented in the following paragraphs.

According to the *direct-match rule*, the method must first find pieces entirely described by edges instead of extension lines or combinations of edges with extension lines.

The $2^{1/2} - 3^{1/2}$ *edge-match rule* requires that in the case of triangular shapes, two sides must be completely defined by edges, while the remaining side can be defined by a combination of collinear edges and extension lines. In addition, the combination should include at least a part of an edge. Also, for four-sided pieces, the rule requires that the additional side is also fully described by an edge. In the end, it is expected to fit the pieces into the formed sub-puzzles. An advantage of this approach is its simplicity of implementation.

The algorithm rearranges the pieces correctly for most examples presented in the original paper, but the authors present cases in which it is not possible to obtain satisfactory results. In addition, the approach is limited to patterns without holes and only allows rotations of pieces by angles at multiples of 45 degrees.

B. Method based on neural networks

Oflazer [7] presents a computational technique to the placement of tangram pieces based on a non-restricted Boltzmann Machine [8]. The pieces are initially laid out on a regular grid. Possible positions and rotations are represented by neural units that receive excitatory connections (Exc) from input units that define the puzzle, and lateral inhibitory (Inh) connections of conflicting units. Figure 3 shows a representation of the neuron used to define the position and orientation of a tangram piece. The sum of the inputs determine the output according to the logistic probability function for Boltzmann Machines.

Oflazer presents tests performed over ten patterns commonly used in the tangram puzzle. According to the author, the method succeeds and converges in a few hundred iterations. However, it limits the rotations of pieces by angles at multiples of 45 degrees due to the regular grid.

C. Method based on genetic algorithm

Bartoněk [5] presents an evolutionist approach for solving polygonal jigsaw puzzles [3]. This method presents an extension for the solution of tangram puzzles in which pieces are represented by string codes. In a string code, the edges

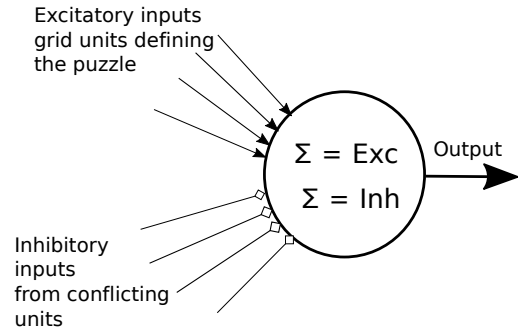

Fig. 3. Representation of a neural unit used in the work of Oflazer representing a single placement and orientation of a tangram piece [7].

and angles are represented by integer numbers invariant to rigid body transformations, as shown in Figure 4. Based on the theory of cluster analysis [9], each piece is assigned to a certain group according to the calculated similarity between the piece and the other pieces belonging to the same group based on its string codes. An evaluation function (fitness) determines how many groups the pieces will be divided into.

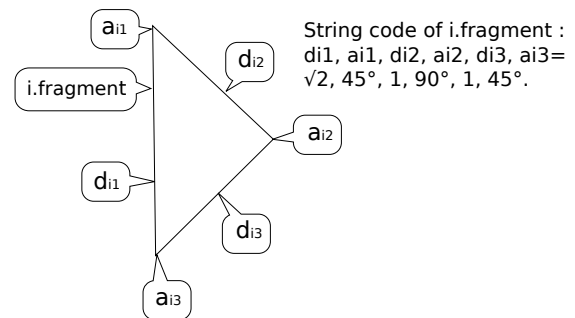

Fig. 4. Tangram piece represented by string codes [5]. The piece i is represented by the sequence $d_{ij} a_{ij}$, in which d_{ij} represents the length of the edge and a_{ij} represents the angle formed by d_{ij} and d_{ij+1} .

D. Method based on algebraic concepts

Kovalsky *et al.* [6] present a method for solving jigsaw puzzles in terms of algebraic concepts. The puzzle is modeled as a system of polynomial equations so that any solution of the system is a solution of the puzzle as a complete representation. The authors first propose to solve edge-matching puzzles. However, they show how to apply their approach to tangram puzzles by considering the tangram as an edge-matching puzzle in which all pieces have the same color. Figure 5 shows an example of the application of this method. In that example, the orientation of each piece is fixed. The authors argue that the method can be modified to assimilate the solution of puzzles with rotations, although limited to a discrete set of rotations.

III. PRELIMINARY COMPARISON

A tangram puzzle solving technique must be able to solve at least the simplest tangram puzzles which can be fully characterized by a set of translations and discrete rotations to form a pattern composed of a simply-connected polygon.

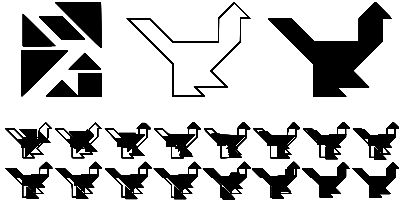

Fig. 5. Example of the technique developed by Kovalsky *et al.* applied to the tangram [6]. In the first row, the pieces in the initial configuration (left), the desired pattern (center) and the arrangement obtained (right). The second and third rows show the intermediate stages of the solution of the system of equations.

However, it is desired that a tangram puzzle solving technique be able to solve more complex tangram puzzles. These may be composed of multiply-connected regions, possibly with holes. In addition, they may require non-discrete rotations, as well as the reflection (flip) operation for the parallelogram. Table I summarizes the main aspects and limitations of each approach as claimed by their authors.

TABLE I
PRELIMINARY COMPARISON OF COMPUTATIONAL METHODS TO SOLVE
TANGRAM PUZZLES

Methods	Discrete rotations only?	Allow reflection operations?	Solve patterns with holes?	Solve patterns with multiply-connected regions?
Deutsch & Hayes	Yes	Yes	No	No
Oflazer	Yes	Yes	Yes	No
Bartonek	Yes	No	No	No
Kovalsky	Yes	No	No	No

Our first analysis shows that the neural network method by Oflazer is more flexible in the sense of solving the tangram puzzle for patterns with holes and patterns which require the parallelogram reflection transformation. However, all the aforementioned approaches show limitations with respect to piece orientation, usually limiting rotations to a discrete set of multiples of 45 degrees. In addition, none of the approaches proved to be applicable in the solution of patterns with multiply-connected regions. We consider that the information contained in the corresponding papers are not sufficient to establish a comparison of performance and obtained arrangements between the approaches. Therefore, we propose to conduct a comparative study between these methods by implementing them and performing puzzle solving tests on a common set of test cases.

IV. METHODOLOGY

The methods will be implemented and evaluated in a common test bed. In the following, we present an overview of our proposed test cases and comparison criteria.

A. Test cases

We will use a common set of test cases covering different configurations such as patterns with perfect fit of pieces,

patterns with missing pieces, patterns with spare pieces and patterns with holes. To better understand the limitations on the rotation of the pieces, the test cases will include patterns that do not require piece rotation, patterns that can be obtained through a discrete set of multiples of 45-degree orientations, and patterns in which the pieces are not limited to a discrete set of rotations. Furthermore, we will consider cases that require the reflection transformation of the parallelogram.

B. Comparison criteria

We will consider a set of quantitative and qualitative aspects for an initial comparative analysis. For quantitative aspects, we plan to include performance metrics such as processing time and memory consumption, and coverage metrics such as the area of the pattern covered and exceeded by the pieces. Qualitative aspects should include the identification of conceptual limitations of each approach, difficulty of implementation, the ability to obtain approximate or partial results, identification of cases that could not be solved, qualification of the obtained results by checking the occurrence of overlapping pieces, use of all pieces and occurrence of space between pairs of pieces.

After this first stage of analysis, the qualitative and quantitative results obtained will be discussed in order clarify some points. First, we will consider in which aspects each approach is superior or inferior compared to the others. Then, we can determine if there are limitations that no technique was able to solve. After that, we can determine what are the general limitations of the problem of solving tangram puzzles using computational techniques. Furthermore, we can verify if there are techniques applied to other types of planar puzzles that can solve the identified limitations.

V. PRELIMINARY RESULTS

We started our study by the heuristic technique proposed by Deutsch & Hayes, in which the authors propose to solve tangram puzzles using simple placement and extraction rules.

We have obtained preliminary results over the extension lines generation procedure. Figure 6 shows the tangram puzzles solutions and the extension lines obtained for each desired pattern. The desired patterns (i.e. the puzzle outlines) are shown as green lines. Concave-type vertices are shown as red dots. Convex-type vertices are shown as blue dots, and the obtained extension lines are shown as dashed blue lines. All pieces and composites can be placed along the extension lines and edges of the puzzle outline. Therefore, as the authors suggested, we can obtain each puzzle solution by using combinations of sub-puzzles separated by the extension lines to fit the pieces.

According to the authors, the heuristic method cannot solve for patterns with holes. Also, we noticed that the method cannot solve for patterns composed by multiply-connected regions. In order to overcome this limitation, we propose to perform a preprocessing operation in which the pattern is partitioned in two or more sub-puzzles. After obtaining the pattern outline, we consider each vertex of the contour by starting with the top-leftmost vertex and proceeding in the

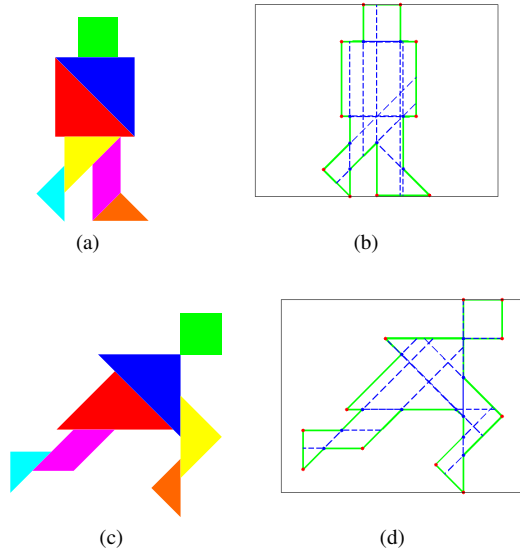

Fig. 6. Tangram puzzles solutions and results of the extension lines generation procedure. (a) Tangram “robot” puzzle solution; (b) Tangram “robot” puzzle extension lines; (c) Tangram “running person” puzzle solution; (d) Tangram “running person” puzzle extension lines.

clockwise direction. If we find two vertices that share the same coordinates, we extract the outline vertices located between these two vertices and consider them as a separated sub-puzzle. Then, we apply the extension lines extraction procedure in each obtained sub-puzzle and in the remaining pattern outline.

Preliminary results of the preprocessing operation and the obtained representation and extension lines are shown in Figure 7.

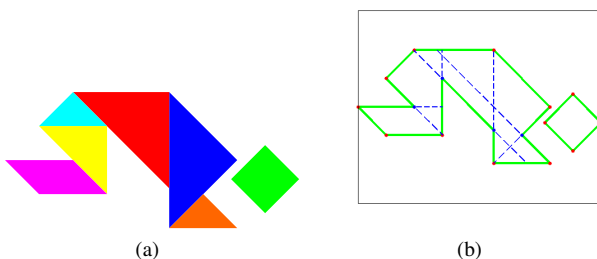

Fig. 7. Preprocessing operation considering patterns composed of multiple contours. (a) Tangram “praying person” puzzle solution; (b) Tangram “praying person” puzzle extension lines.

VI. FINAL CONSIDERATIONS

In this paper, we present preliminary results of an ongoing comparative study of four computational methods to solve tangram puzzles based on computational heuristics, genetic algorithms, artificial neural networks and algebraic representations.

Although the literature related to computational methods for solving jigsaw and edge-matching puzzles is broad, the development of computational techniques for solving dissection

puzzles in particular is still a barely explored field. Among the approaches identified in the literature, only the techniques proposed by Deutsch & Hayes and Oflazer are designed for solving tangram puzzles. The others are variations of jigsaw and edge-matching puzzle techniques in which the authors present adaptations for their use in tangram puzzles, usually with limitations.

We presented our implementation of the extension lines generation procedure presented in the heuristic method proposed by Deutsch & Hayes. So far, the obtained results are satisfactory and the procedure has proved efficient in the puzzle partitioning process. We have proposed a modification on the method in order to extract the extension lines from patterns composed by multiply-connected regions.

We intend to propose further improvements for cases not covered by the original method by Deutsch & Hayes, as well as to implement the other approaches identified in the literature. In addition, during the development of this research, we aim to identify the advantages and limitations of each approach and propose possibilities of improvement for new computational methods to solve dissection puzzles.

ACKNOWLEDGMENT

This research has been supported by CAPES (Brazilian Coordination for Improvement of Higher Level Personnel).

REFERENCES

- [1] J. E. C. Castanho and C. L. Tozzi, “Obtenção da transformação de corpo rígido em registro de imagens com deformação usando thin plate splines,” in *Anais...*, L. Velho, A. d. Albuquerque, and R. A. Lotufo, Eds., Simpósio Brasileiro de Computação Gráfica e Processamento de Imagens, 9. (SIBGRAPI). Porto Alegre: Sociedade Brasileira de Computação, 1996, Aplicações em Medicina, pp. 181–187. [Online]. Available: <http://urlib.net/dpi.inpe.br/ambro/1998/04.27.11.28>
- [2] E. S. Deutsch and K. C. Hayes Jr., “A heuristic solution to the tangram puzzle,” *Machine Intelligence*, vol. 7, pp. 205–240, 1972.
- [3] F. A. Andaló, G. Taubin, and S. Goldenstein, “Solving image puzzles with a simple quadratic programming formulation,” in *Proceedings...*, C. M. D. S. Freitas, S. Sarkar, R. Scopigno, and L. Silva, Eds., Conference on Graphics, Patterns and Images, 25. (SIBGRAPI). Los Alamitos: IEEE Computer Society Conference Publishing Services, 2012.
- [4] E. D. Demaine and M. L. Demaine, “Jigsaw puzzles, edge matching, and polyomino packing: Connections and complexity,” *Graphs and Combinatorics*, vol. 23, no. 1, pp. 195–208, 2007.
- [5] D. Bartoněk, “A genetic algorithm how to solve a puzzle and its using in cartography,” *Acta Scientiarum Polonorum. Geodesia et Descriptio Terrarum*, vol. 4, no. 2, pp. 15–23, 2005.
- [6] S. Z. Kovalsky, D. Glasner, and R. Basri, “A global approach for solving edge-matching puzzles,” *SIAM Journal on Imaging Sciences*, vol. 8, no. 2, pp. 916–938, 2015.
- [7] K. Oflazer, “Solving tangram puzzles: A connectionist approach,” *International journal of intelligent systems*, vol. 8, no. 5, pp. 603–616, 1993.
- [8] R. Salakhutdinov and G. E. Hinton, “Deep boltzmann machines.” in *AISTATS*, vol. 1, 2009, p. 3.
- [9] M. R. Anderberg, *Cluster analysis for applications: probability and mathematical statistics: a series of monographs and textbooks*. Academic press, 2014, vol. 19.